

DC AIR CONDITIONER

HHEX-ACZB-030-XXX-050 / 3000W



PRODUCT OVERVIEW

DC Air Conditioner

The unit is specially designed for cooling electronic equipment in challenging outdoor environments and is often used in on or off grid telecom enclosure, telecommunication base station cooling, smart grid outdoor cabinet cooling as well as all kinds of industry automation control boxes.

High efficiency DC powered active cooling device that eliminates inverter components.

Can be easily integrated into customer advanced management system, it will reduce OPEX up to 70%, reduce carbon footprint and maximized network availability.

Low voltage disconnect feature prolongs battery life in case of low voltage and the unit is therefore highly suitable for off grid sites with renewable energy sources such as solar PV, winds, fuel cells, diesel generator combined hybridization system.

Feature & benefits

- Energy-efficient, reduce OPEX through optimized energy management system, (normally it is a combination system among diesel generator, fuel cell, solar PV with battery bank)
- BLDC motor technology enable variable speed control feature for both fans and compressor
- Compact product line is a mono-block unit with a plug and play feature ensures immediately set up also with flange design for convenient through wall (or cabinet door) mounting.
- Using environmentally friendly refrigerant R134a.
- Closed loop cooling protects equipment from ambient environment, with adjustable indoor temperature set point from 20-40-degree, ventilation not recommended anymore since the system highest efficiency.
- Adaptable for T3 condition with ip to 500 degrees tropic climate

Contact Details

T. +46 763 916 550

info@hunterhex.com
sales@hunterhex.com

HUNTERHEX AB
EMEA Office
Färögatan 33
SE-164 51 Kista
Sweden

Model Definition:
 ACZB-030-006-050
 ACZB-030-000-050

050: Product ID
 000: No heater, 006: Heater Size 600W
 030: Cooling Capacity 3000W
 B: Refrigerant = R134a
 Z: DC Power Supply
 C: Cabinet Application
 A: Air Conditioner

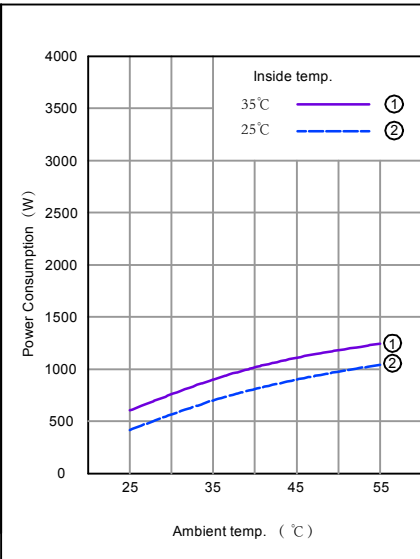
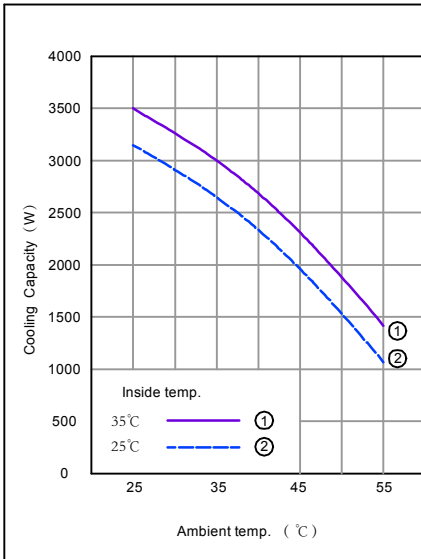

DC power supply range	48VDC (40 ~ 60VDC)
Cooling capacity	3000W @ 35°C / 35°C
Rated power Consumption	900W @ 35°C / 35°C
Rated current	18.8A @ 35°C / 35°C
Inner circulation air flow rate	800m³/h
Display	LED
Heater	600W (Option per order)
Heater power supply range	48VDC (40 ~ 60VDC)
Operating temperature range	-15°C ~ +55°C
Max. noise level	65dB(A) @ 1.0m away
IP protection level	IP55 - between external and internal interface
Net weight	65Kg
Outer dimension	1150x485x225 (mm,HxWxD)
Refrigerant type	R134a
Certification	CE
Surface treatment	Outdoor type powder coating, standard color: RAL7035
Lifetime	10 years

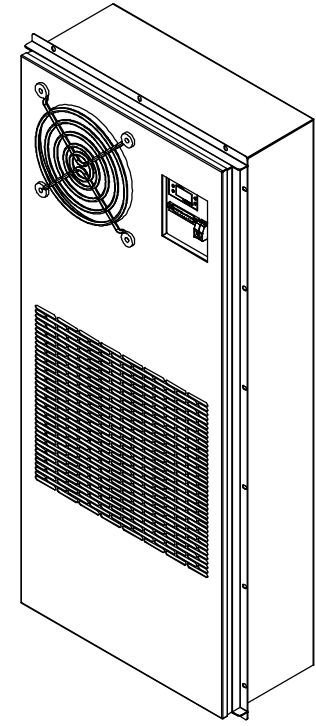
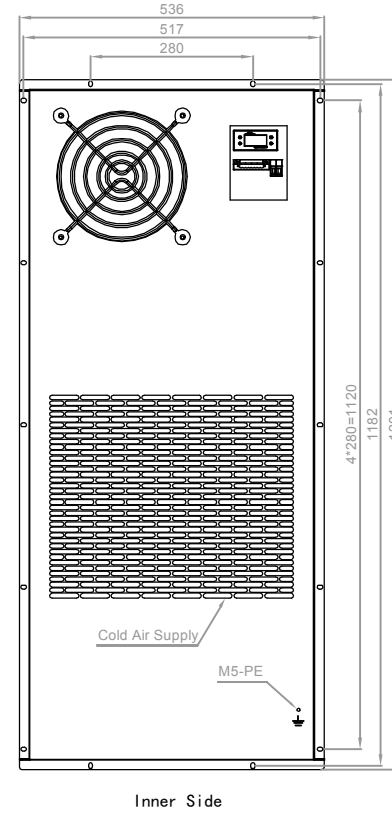
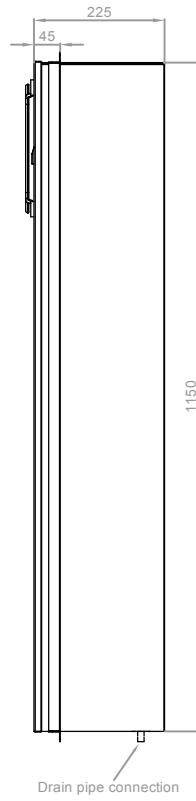
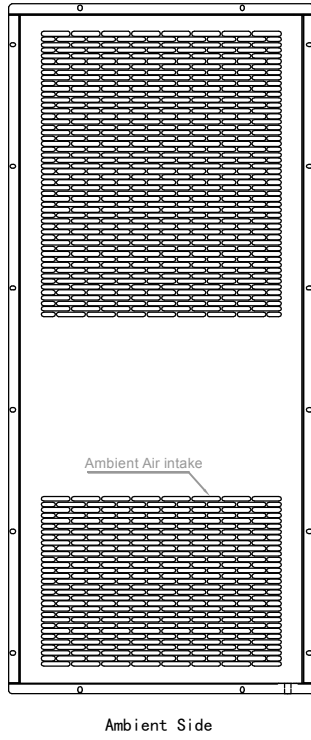

	P/N:	711050	Ver.:	A
	Name:	3000W DC Air Con.		
	Model:	ACZB-030-006-050		
		ACZB-030-000-050		

Figure 1 - Installation tips if extra cowling needed by customer

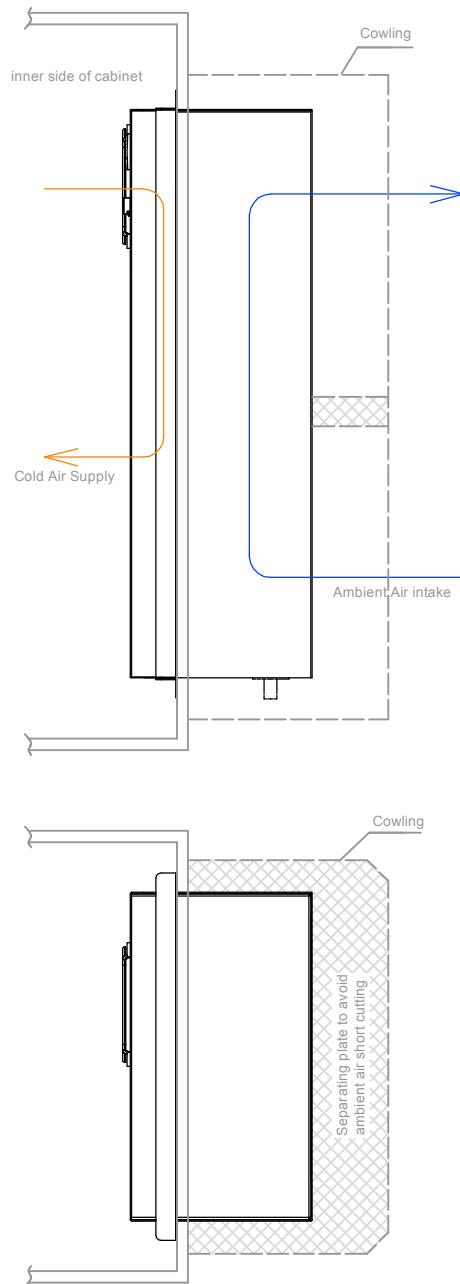

Note:
 It is not recommended to add extra cowling
 While if customer insist on doing that, please follow below rules:
 1. The louvers for ambient air intake and discharge must keep 70% above open area for having sufficient air flow
 2. A separating plate must be added to avoid air short cut between intake & exhaust air

Figure 2 - Mounting interface with cabinet door

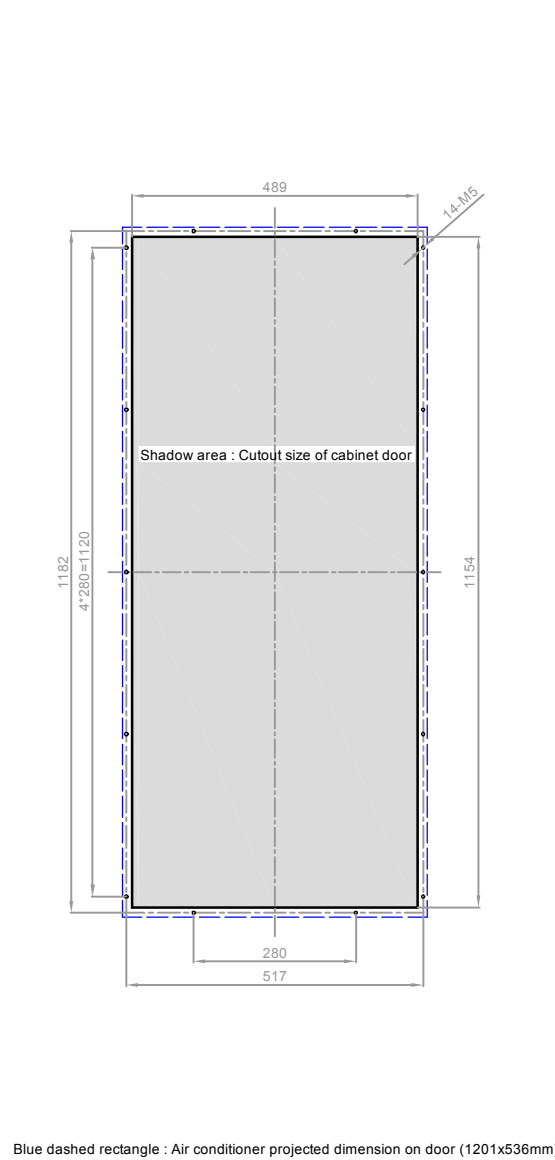

Figure 3 - Wiring interface with customer circuit

No.	symbol	Definition
1	T/R+	T/R+ port for RS485 communication
2	T/R-	T/R- port for RS485 communication
3	NC	Normally Closed port for alarming signal output
4	COM	Common Port for Alarming signal output
5	NO	Normally open port for alarming signal output
6		
7	CONTROL	Control signal input : on / off dry switch type
8	/	/
9	+V	Pole : DC - positive
10	-V	Pole : DC - negative

Display explanation :
 LED will show inner air temp. at normal working, while also show alarming code when alarming triggered.

Status bar : with indicator light

- Keep lighting when do parameter setting
- Keep blinking when unit carry out self testing process
- Keep lighting under normal cooling operation
- Keep lighting under normal heating operation
- Keep lighting when external cycle fan start working
- Keep blinking for alarming triggered

	P/N:	711050	Ver.:	A
	Name:	3000W DC Air Con.		
	Model:	ACZB-030-006-050		
		ACZB-030-000-050		