

# AC AIR CONDITIONER

HHEX-AIYB-030-XXX-040 / 3000W

---



# PRODUCT OVERVIEW

## AC Air Conditioner

The unit is specially designed for cooling electronic equipment in challenging outdoor environments and is often used in on or off grid telecom enclosure, telecommunication base station cooling, smart grid outdoor cabinet cooling as well as all kind of industry automation control boxes.

High efficiency AC powered cooling device for enclosed space like outdoor cabinet, shelter application.

Can be easily integrated into customer advanced management system, it will reduce OPEX up to 50%, reduce carbon footprint and maximized network availability.

### Feature & benefits

- Energy-efficient, reduce OPEX through optimized energy management system, (normally it is a combination system among diesel generators, fuel cell, solar PV with battery bank)
- Compact product line is a mono-block unit with a plug and play future ensures immediately set up also with flange design for convenient through-wall (or cabinet) mounting.
- Using environmentally friendly refrigerant R134a
- Closed loop cooling protects equipment from ambient environment, with adjustable indoor temperature set point from 20-40°C degree, ventilation not required since system having highest efficiency.
- Remote measuring, remote communication, remote control, witch can realize multiple automatic protection and comprehensive self-testing function.
- Multiple self-protection design & visible monitoring interface, RS485 communication port (MODBUS-RTU protocol)
- LED display, all the settings can be changed at the field.
- Adaptable for T3 condition up to 55°C degree tropical climate.

### Contact Details

T. +46 763 916 550

info@hunterhex.com  
sales@hunterhex.com

HUNTERHEX AB  
EMEA Office  
Färögatan 33  
SE-164 51 Kista  
Sweden

Model Definition:

A I Y B - 0 3 0 - 0 1 0 - 0 4 0  
A I Y B - 0 3 0 - 0 0 0 - 0 4 0

- 040: Product ID
- 000: No heater, 010: Heater Size 1000W
- 030: Cooling Capacity 3000W
- B: Refrigerant = R134a
- Y: 230VAC 50HZ Power Supply
- I: Industry Application
- A: Air Conditioner

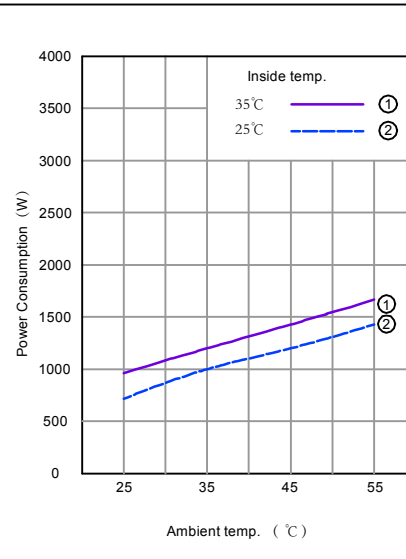
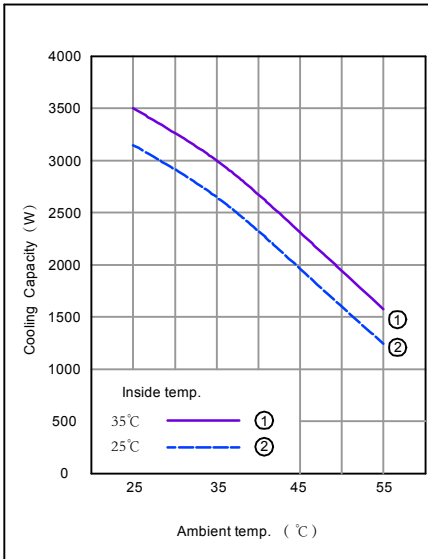
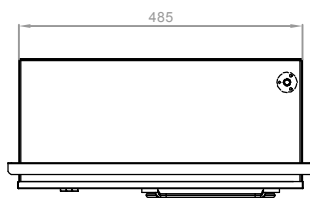

DC power supply range	230VAC ±15% / 50Hz
Cooling capacity	3000W @ 35°C / 35°C
Rated power Consumption	1200W @ 35°C / 35°C
Rated current	5.2A @ 35°C / 35°C
Inner circulation air flow rate	800m³/h
Display	LED
Heater	1000W (Option per order)
Heater power supply range	230VAC ±15% / 50Hz
Operating temperature range	-15°C ~ +55°C
Max. noise level	65dB(A) @ 1.0m away
IP protection level	IP55 - between external and internal interface
Net weight	70Kg
Outer dimension	1150x485x225 (mm,HxWxD)
Refrigerant type	R134a
Certification	CE
Surface treatment	Outdoor type powder coating, standard color: RAL7035
Lifetime	10 years

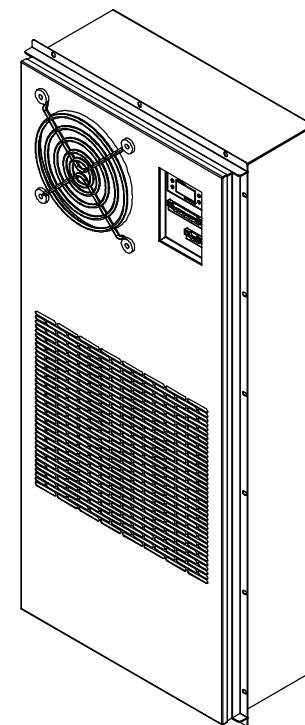
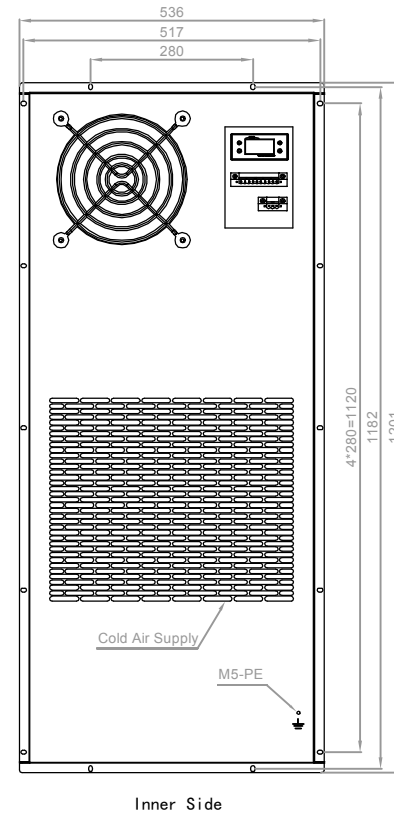
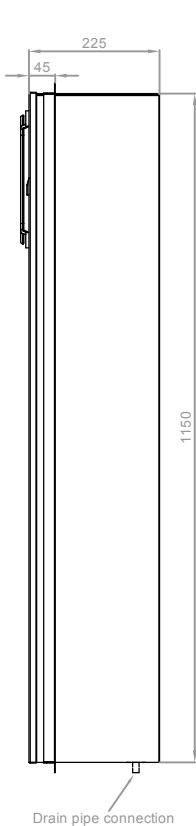
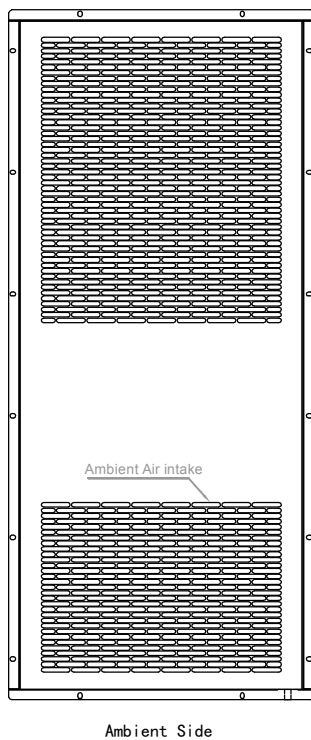

	P/N:	732040	Ver.:	A
	Name:	3000W AC Air Con.		
	Model:	AIYB-030-010-040 AIYB-030-000-040		

Figure 1 - Installation tips if extra cowling needed by customer

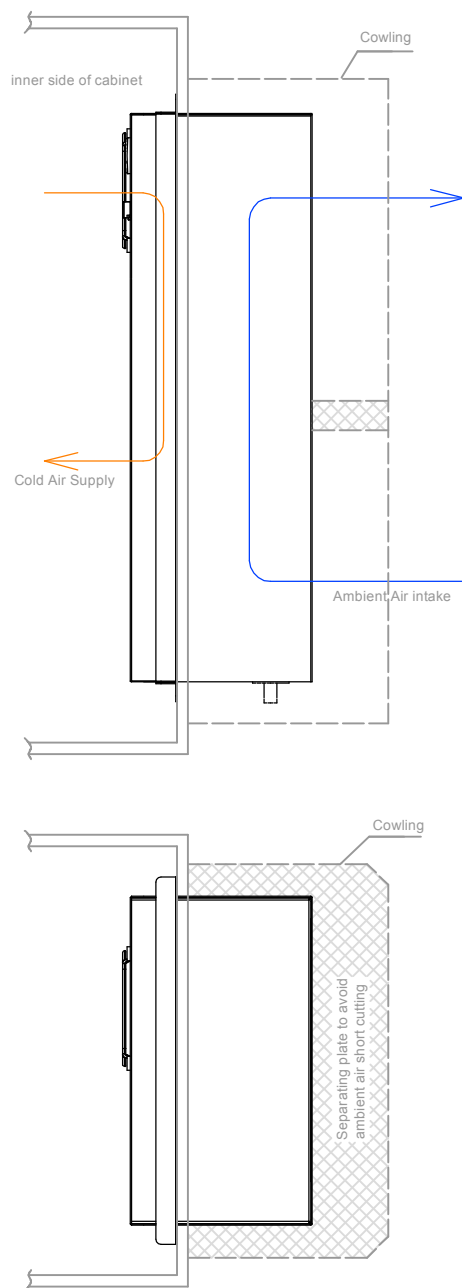

**Note:**  
It is not recommended to add extra cowling  
While if customer insist on doing that, please follow below rules:  
1. The louvers for ambient air intake and discharge must keep 70% above open area for having sufficient air flow  
2. A separating plate must be added to avoid air short cut between intake & exhaust air

Figure 2 - Mounting interface with cabinet door

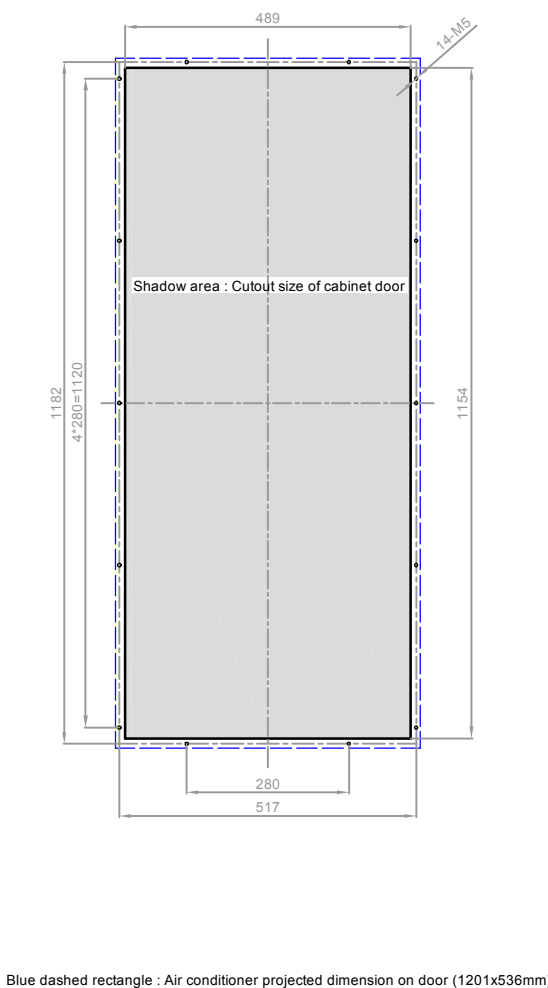

Figure 3 - Wiring interface with customer circuit

No.	symbol	Definition
1	T/R+	T/R+ port for RS485 communication
2	T/R-	T/R- port for RS485 communication
3	NC	Normally Closed port for alarming signal output
4	COM	Common Port for Alarming signal output
5	NO	Normally open port for alarming signal output
6	CONTROL	Control signal input : on / off dry switch type
7	/	/
8	/	/
9	/	/
10	/	/
11	L	Pole : AC - L
12	N	Pole : AC - N

Display explanation :  
LED will show inner air temp. at normal working, while also show alarming code when alarming triggered.

Status bar : with indicator light

- Keep lighting when do parameter setting
- Keep blinking when unit carry out self testing process
- Keep lighting under normal cooling operation
- Keep lighting under normal heating operation
- Keep lighting when external cycle fan start working
- Keep blinking for alarming triggered

	P/N:	732040	Ver.:	A
	Name:	3000W AC Air Con.		
	Model:	AIYB-030-010-040 AIYB-030-000-040		