

Model Definition:
 ACZB-030-006-050
 ACZB-030-000-050

050: Product ID
 000: No heater, 006: Heater Size 600W
 030: Cooling Capacity 3000W
 B: Refrigerant = R134a
 Z: DC Power Supply
 C: Cabinet Application
 A: Air Conditioner

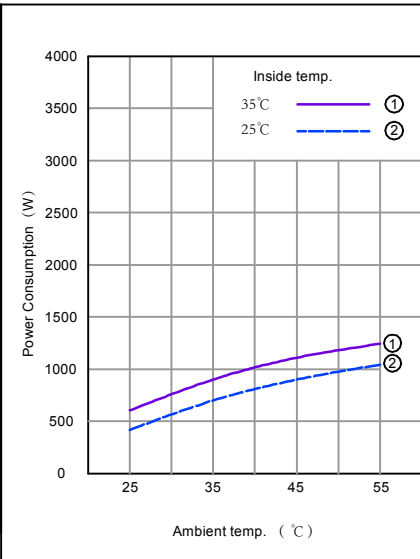

DC power supply range	48VDC (40 ~ 60VDC)
Cooling capacity	3000W @ 35°C / 35°C
Rated power Consumption	900W @ 35°C / 35°C
Rated current	18.8A @ 35°C / 35°C
Inner circulation air flow rate	800m³/h
Display	LED
Heater	600W (Option per order)
Heater power supply range	48VDC (40 ~ 60VDC)
Operating temperature range	-15°C ~ +55°C
Max. noise level	65dB(A) @ 1.0m away
IP protection level	IP55 - between external and internal interface
Net weight	65Kg
Outer dimension	1150x485x225 (mm,HxWxD)
Refrigerant type	R134a
Certification	CE
Surface treatment	Outdoor type powder coating, standard color: RAL7035
Lifetime	10 years

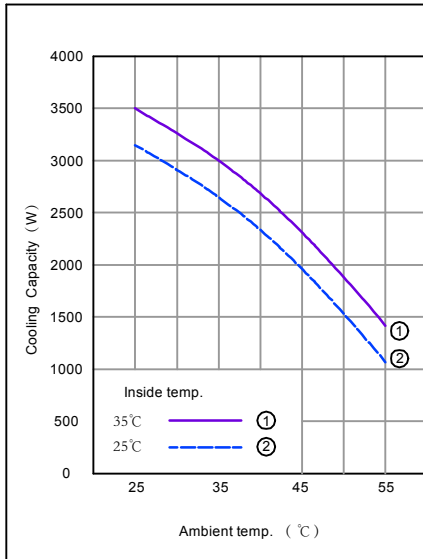
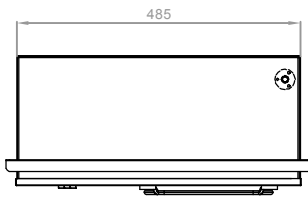
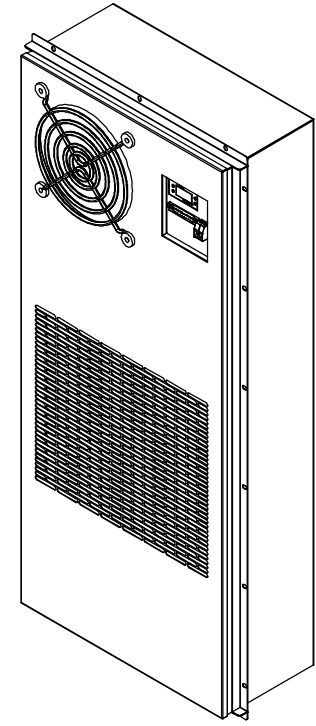
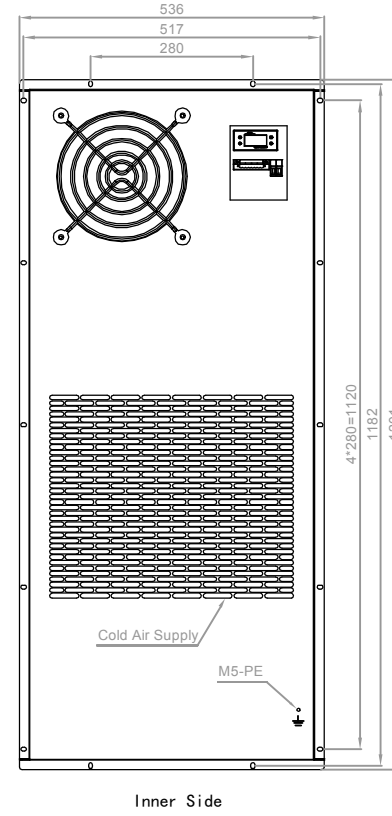
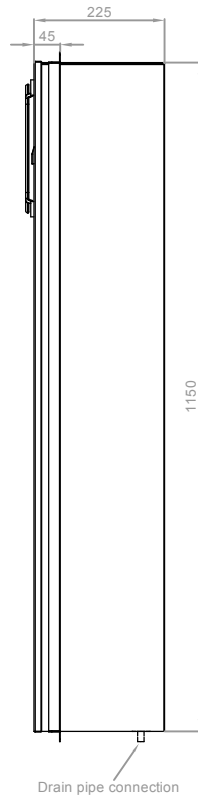
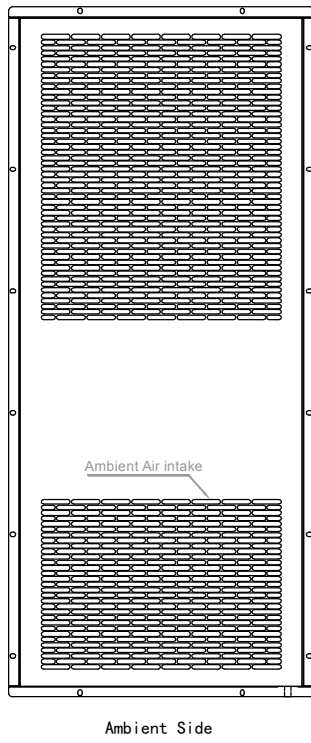

		P/N: 711050	Ver.: A
		Name: 3000W DC Air Con.	
		Model: ACZB-030-006-050	
		ACZB-030-000-050	

Figure 1 - Installation tips if extra cowling needed by customer

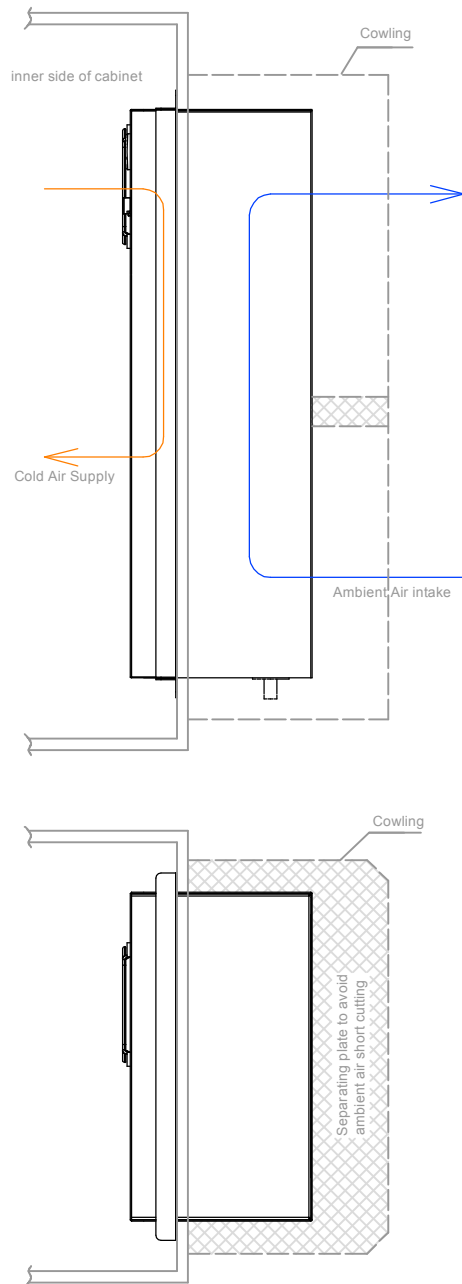

Note:
 It is not recommended to add extra cowling
 While if customer insist on doing that, please follow below rules:
 1. The louvers for ambient air intake and discharge must keep 70% above open area for having sufficient air flow
 2. A separating plate must be added to avoid air short cut between intake & exhaust air

Figure 2 - Mounting interface with cabinet door

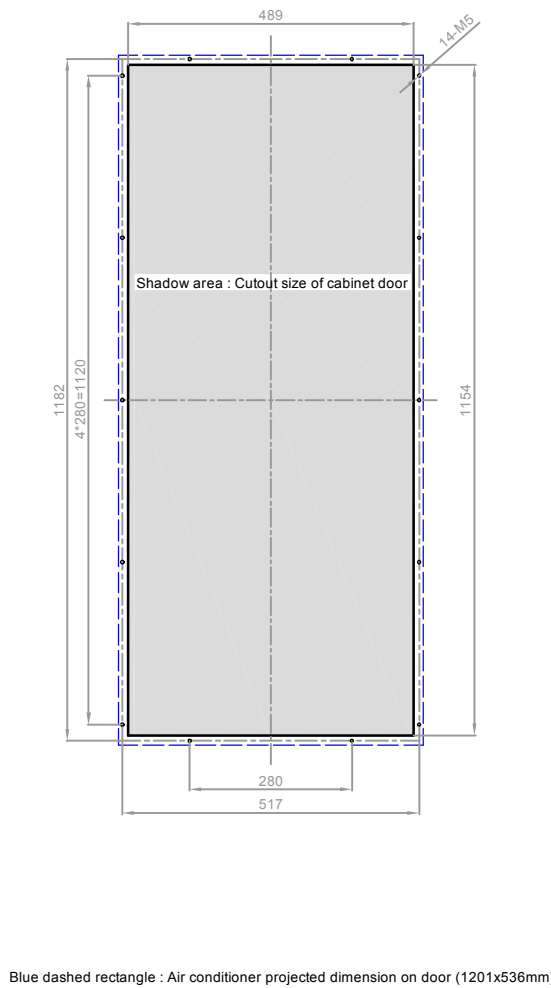
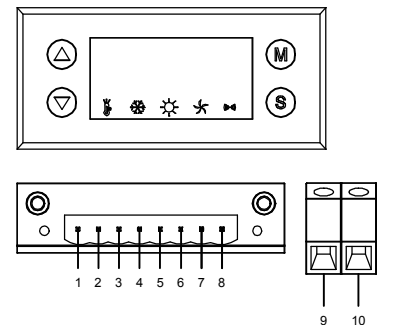

Figure 3 - Wiring interface with customer circuit



No.	symbol	Definition
1	T/R+	T/R+ port for RS485 communication
2	T/R-	T/R- port for RS485 communication
3	NC	Normally Closed port for alarming signal output
4	COM	Common Port for Alarming signal output
5	NO	Normally open port for alarming signal output
6		
7	CONTROL	Control signal input : on / off dry switch type
8	/	/
9	+V	Pole : DC - positive
10	-V	Pole : DC - negative

Display explanation :
 LED will show inner air temp. at normal working, while also show alarming code when alarming triggered.

- Status bar : with indicator light
- Keep lighting when do parameter setting
 - Keep blinking when unit carry out self testing process
 - Keep lighting under normal cooling operation
 - Keep lighting under normal heating operation
 - Keep lighting when external cycle fan start working
 - Keep blinking for alarming triggered

		P/N: 711050	Ver.: A
		Name: 3000W DC Air Con.	
		Model: ACZB-030-006-050	
		ACZB-030-000-050	